

RH10 - Régulateur très haute pression, 220 bar, FKM, PTFE, compatible avec de nombreux gaz : dioxyde de carbone, argon, helium, hydrogène, méthane, oxygène ...

Description	For outlet pressures up to 15 bar the regulator has a diaphragm, for higher outlets a piston. A sintered bronze filter at the inlet port protects against contamination.	
Media	compressed air or non-corrosive gases	
Supply pressure	max. 220 bar	
Adjustment	RH10-02: by black plastic knob	all others: by T-handle with locknut
Gauge port	All regulators are equipped with both one supply pressure gauge and one outlet pressure gauge.	
Safety relief valve	prevents from overpressure, see chart	
Compensation	All regulators are equipped with supply pressure variation compensation, so that a change in supply pressure has no effect on the outlet pressure's stability.	
Temperature range	-20 °C to 60 °C / -4 °F to 140 °F	
Material	Body: brass, nickel-plated at RH10-02 Piston: brass at RH10-02 Valve seat: nylon Diaphragm: stainless steel at RH10-02, NBR/Buna-N at all others	Mounting position any Inlet filter: sintered bronze O-rings: EPDM or FKM, dependent on media

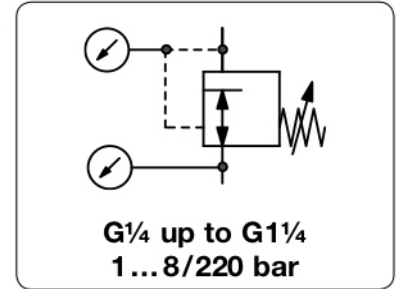

Dimensions			Safety relief valve	K _v -value	Flow rate	Connection thread	Pressure range	Order number
A	B	C	S: with valve	(m ³ /h)	m ³ /h*1	inlet / outlet	bar	

High pressure regulator 220 bar								non-relieving, for compressed air, pressure gauges supplied	RH10	
175	150	32	S	0.05	80	1300	DIN 477 / G 1/4	1 ... 8	RH10-02A	
			S						1 ... 15	RH10-02B
			S						3 ... 30	RH10-02C
			S						5 ... 50	RH10-02D
			S						10 ... 100	RH10-02E
			-					20 ... 200	RH10-02F	
181	162	34	S	0.15	228	3800	DIN 477 / G 1/2 a	0.1 ... 1.5	RH10-030	
			S					1 ... 15	RH10-03B	
			S					3 ... 30	RH10-03C	
181	164	34	S				DIN 477 / G 3/8 i	5 ... 50	RH10-03D	
			S	10 ... 100	RH10-03E					
181	182	34	-					20 ... 200	RH10-03F	
			-							
181	231	102	S	0.25	422	7000	G 3/4 i / G 1/2 a	0.1 ... 1.5	RH10-A30	
			S					1 ... 15	RH10-A3B	
181	233	102	S				G 3/4 i / G 3/8 i	3 ... 30	RH10-A3C	
			S	5 ... 50	RH10-A3D					
181	184	35	-					10 ... 100	RH10-A3E	
			-						20 ... 200	RH10-A3F
166	346	113	S	1.5	2000	33000	G 3/4 a / G 3/4 a	1 ... 8	RH10-06A	
			S					1 ... 15	RH10-06B	
			S					3 ... 30	RH10-06C	
			S					5 ... 50	RH10-06D	
			S					10 ... 100	RH10-06E	
250	370	242	S	2.5	3000	48000	G 1 a / G 1 a	1 ... 8	RH10-08A	
			S					1 ... 15	RH10-08B	
250	406	278	S					3 ... 30	RH10-08C	
			S	5 ... 50	RH10-08D					
250	387	276	-					20 ... 200	RH10-08F	

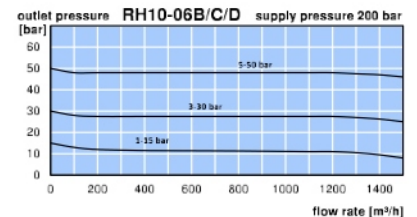
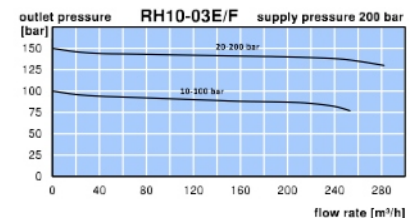
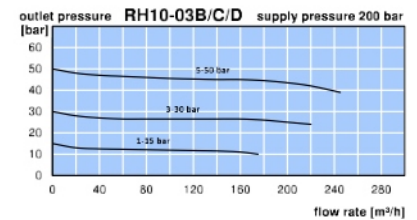
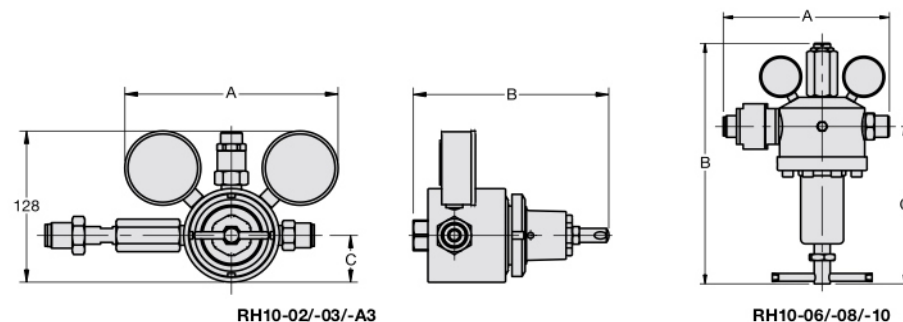

*1 at 200 bar supply pressure and 15 bar outlet pressure

*2 max. 80 bar outlet pressure

RH10 - Régulateur très haute pression, 220 bar, FKM, PTFE, compatible avec de nombreux gaz : dioxyde de carbone, argon, helium, hydrogène, méthane, oxygène ...

Description	For outlet pressures up to 15 bar the regulator has a diaphragm, for higher outlets a piston. A sintered bronze filter at the inlet port protects against contamination.	
Media	compressed air or non-corrosive gases	
Supply pressure	max. 220 bar	
Adjustment	RH10-02: by black plastic knob	all others: by T-handle with locknut
Gauge port	All regulators are equipped with both one supply pressure gauge and one outlet pressure gauge.	
Safety relief valve	prevents from overpressure, see chart	
Compensation	All regulators are equipped with supply pressure variation compensation, so that a change in supply pressure has no effect on the outlet pressure's stability.	
Temperature range	-20 °C to 60 °C / -4 °F to 140 °F	
Material	Body: brass, nickel-plated at RH10-02 Piston: brass at RH10-02 Valve seat: nylon Diaphragm: stainless steel at RH10-02, NBR/Buna-N at all others	Mounting position any Inlet filter: sintered bronze O-rings: EPDM or FKM, dependent on media

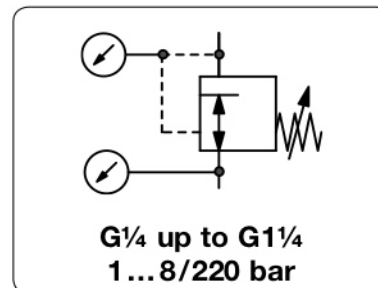

Dimensions			Safety relief valve	K _v -value	Flow rate	Connection thread	Pressure range	Order number
A	B	C	S: with valve	(m ³ /h)	m ³ /h*1	inlet / outlet	bar	

High pressure regulator 220 bar			non-relieving, for compressed air, pressure gauges supplied				RH10		
246	385	269	S	3.5	5000	80000	G1 a / G1 1/4	1 ... 8	RH10-10A
			S					1 ... 15	RH10-10B
			S					3 ... 30	RH10-10C
246	426	310	S					5 ... 50	RH10-10D



RH10-08B

Special options, add the appropriate letter

relieving diaphragm	with relieving function, for compressed air	RH10-... R
relieving piston	with relieving function, for compressed air	RH10-... R
FKM elastomer		RH10-... V
PTFE elastomer		RH10-... T
SST diaphragm	from RH10-03	RH10-... S
for panel mounting	for RH10-02 to -A3	RH10-... P
carbon dioxide *2	CO ₂	RH10-... 03
argon	Ar	RH10-... 05
nitrogen	N ₂	RH10-... 07
helium	He	RH10-... 09
hydrogen	H ₂	RH10-... 11
methane	CH ₄	RH10-... 13
oxygen	O ₂	RH10-... 15
propane	C ₃ H ₈	RH10-... 16
nitrous oxide	N ₂ O	RH10-... 17
without flange connection		RH10-... X40

Accessories, enclosed

mounting bracket	made of stainless steel	for RH10-02	BW35-01S
mounting nut		for RH10-02	M35x1,5S
mounting bracket		for RH10-03 and -A3	BW50-01S
mounting nut		for RH10-03 and -A3	M50x1,5S
mounting bracket		for RH10-06	BW00-31S
		for RH10-08	BW00-35S

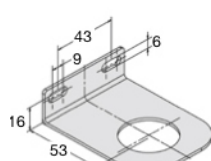
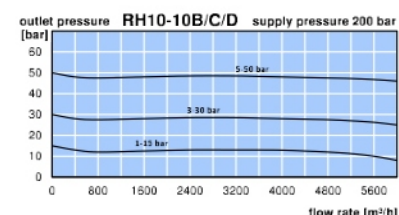
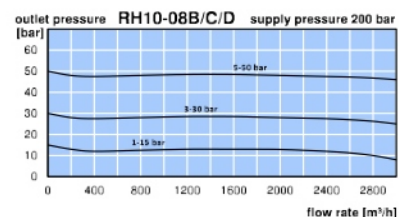

BW35-01S

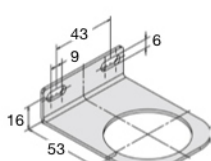

BW50-01S

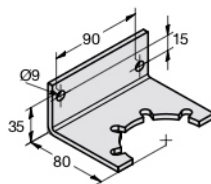

BW00-31S

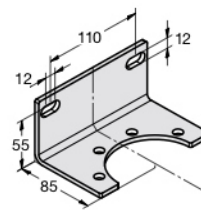

BW00-35S

*1 at 200 bar supply pressure and 15 bar outlet pressure

*2 max. 80 bar outlet pressure

