

# PR - Régulation proportionnel de pression, Airtronic, pour une multitude d'applications industrielles

<b>Description</b>	The pneumatic proportional valve controls the outlet pressure in proportion to an electrical command input signal. It comprises a complete closed loop servo system in a compact monoblock assembly with proportional solenoid valve, electronic regulator and internal pressure transducer.  In the process, the outlet pressure is transformed into a proportional electrical signal and compared with the input signal. If the outlet pressure exceeds the preset setpoint, the valve exhausts down to the pressure desired.  The valve has no constant bleed. At absence of input signal or supply voltage the valve exhausts. The powersupply of the setpoint potentiometer is provided by the proportional valve via connector pin number 5.
<b>Pressure transducer</b>	Open transducers: 100 mbar, 500 mbar, 1 bar and vacuum
<b>Application examples</b>	Proportional pressure regulators are being used for blowing machines, ultrasonic equipments, testing machines, painting systems, contouring systems, laser welding machines, textile machines, cheese presses, pneumatic brakes, clamping devices and medical engineering.

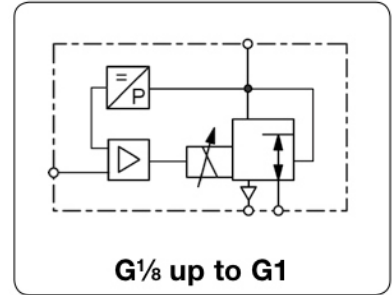

## General technical features

<b>Description</b>	3-port/2-way valve with proportional magnet, integrated hybrid PCB and closed loop with pressure transducer in compact monoblock assembly.
<b>Mounting position</b>	any, preferably upright
<b>Protection class</b>	IP 54 with standard connector, IP 65 with special connector
<b>Shock resistance</b>	3G
<b>Temperature range</b>	0 °C up to 50 °C / 32 °F to 122 °F, high temperature version on request
<b>Material</b>	Body: brass (G <sup>1/8</sup> ) and aluminium (G <sup>1/4</sup> , G <sup>1/2</sup> u. G1) Inner valve: brass and SST Seals: NBR/Buna-N, on request EPDM or FKM FKM for 50 bar version

## Pneumatic features

<b>Media</b>	dry, lubricated, unlubricated and 50 µm filtered compressed air or non-corrosive gases
<b>Supply pressure</b>	see chart, min. 10% above outlet pressure
<b>Flow rate</b>	see chart, at 7 bar inlet pressure and open outlet
<b>Exhaust</b>	same nominal size as on inlet valve, thus same relief capacity
<b>Air consumption</b>	without air consumption

## Electrical features

<b>Supply voltage</b>	24 V DC + 15% - 10%, residual ripple max. 10%
<b>Power consumption</b>	12 W at G <sup>1/8</sup> , 22 W at G <sup>1/4</sup> , 30 W at G <sup>1/2</sup> , 44 W at G1
<b>Current consumption</b>	0.5A at G <sup>1/8</sup> , 1.0A at G <sup>1/4</sup> , 1.25A at G <sup>1/2</sup> , 1.7A at G1
<b>Command signal</b>	0 ... 10 V, 0 ... 20 mA, 4 ... 20 mA, digital or Profibus DB rising curve as standard, optionally declining curve
<b>Impedance</b>	100 kΩ at voltage signal (0.1 mA current consumption) 500 Ω at current signal
<b>Electrical connector</b>	circular plug according to DIN 43651, 7-pin plug for analogue signal 16-pin plug for digital signal

## Accuracy

<b>Linearity/Hysteresis</b>	< 1% FS
<b>Response sensitivity</b>	< 0.1% FS
<b>Repeatability</b>	< 0.1% FS
<b>Over all accuracy</b>	± 0.5%
<b>Regulating time</b>	< 1 s over the range, 70 ms at 10 to 90% or 90 to 10% of the range

## Adjustment

<b>Zero point</b>	calibration ± 10% FS via potentiometer P2
<b>Range</b>	calibration + 5% FS or -10% FS via potentiometer P1
<b>Amplification</b>	calibration 1:1 up to 1:10 via potentiometer P7

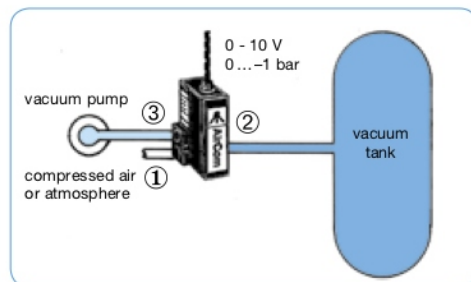

### Downstream regulation (V1)

The vacuum pump saves energy and it is easy to fill the tank either with vacuum or pressure. A filter is recommended at orifice ①.

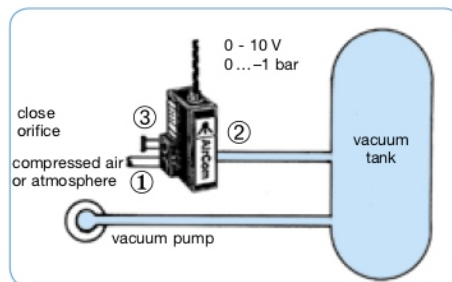

### Upstream regulation (V2)

Upstream installation is preferred if rapid evacuation of a tank or system is required. A filter is recommended at orifice ①.

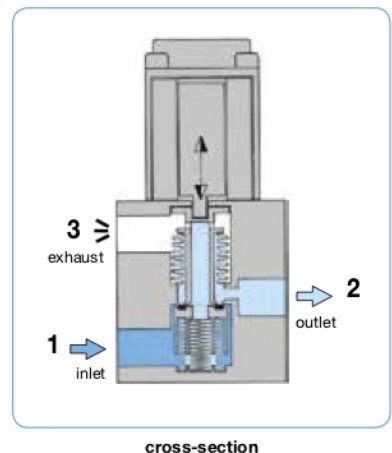
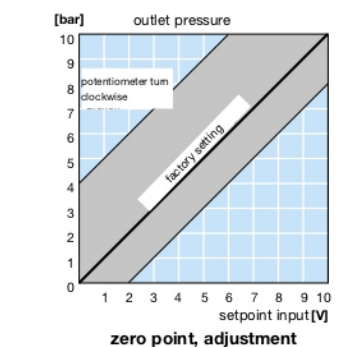
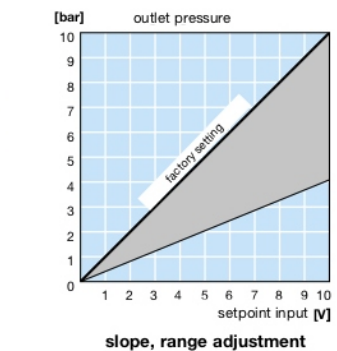
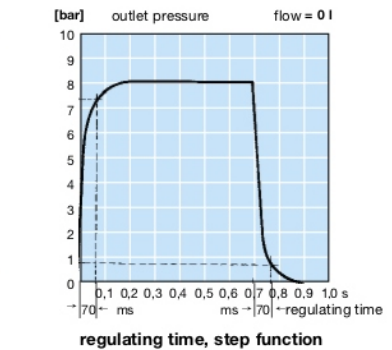

# PR - Régulation proportionnel de pression, Airtronic, pour une multitude d'applications industrielles

### Technical features

• <b>Pressure range</b>	0...-1.0 bar to 0... 1.0 bar	• <b>Linearity / Hysteresis</b>	< 1% FS
• <b>Command signal</b>	0... 10 V, 0...20 mA, 4...20 mA, digital	• <b>Response sensitivity</b>	± 0,5% FS
• <b>Feedback signal</b>	0... 10 V, 0...20 mA, 4...20 mA	• <b>Repeatability</b>	± 0,5% FS
• <b>Adjustment</b>	zero point, range and amplification	• <b>Regulating time</b>	< 1 s
• <b>Pressure sensors</b>	100 / 500 mbar, 1 bar	• <b>Power consumption</b>	12 / 22 / 30 / 44 W
• <b>Flow rate</b>	250 / 820 / 1700 / 6500 l/min	• <b>Exhaust</b>	full nominal size

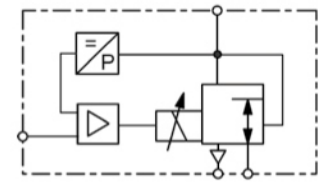

**G<sup>1</sup>/<sub>8</sub> up to G1**  
**0... 100 mbar/50 bar**

Dimensions			Nominal size	K <sub>v</sub> -value	Flow rate	Supply max. bar	Connection thread	Pressure range	Order number
A	B	C							
mm	mm	mm	DN	(m <sup>3</sup> /h)	l/min*1		G	bar	

Proportional pressure valve						0-10 V input signal, supply voltage 24 V DC, with coupling socket		PR	
35	80	63	3	0.18	210	-1	G <sup>1</sup> / <sub>8</sub>	0... -1.0	PRA00-00V1
						-1		0... -0.5	PRA00-00V1A5
						-1		0... -0.1	PRA00-00V1A1
						3		-1.0... 1.0	PRA00-01V1
						1		0... 0.1	PRA00-A100
						2		0... 0.5	PRA00-A500
52	105	74	6	0.6	700	-1	G <sup>1</sup> / <sub>4</sub>	0... -1.0	PR000-00V1
						-1		0... -0.5	PR000-00V1A5
						-1		0... -0.1	PR000-00V1A1
						3		-1.0... 1.0	PR000-01V1
						1		0... 0.1	PR000-A100
						2		0... 0.5	PR000-A500
70	150	101	12	1.2	1400	-1	G <sup>1</sup> / <sub>2</sub>	0... -1.0	PR100-00V1
						2		0... 1.0	PR100-0100
96	190	115	20	4.8	5600	-1	G1	0... -1.0	PR200-00V1
						2		0... 1.0	PR200-0100



PRA



PR1



example: combination PR with booster



PRK-A

PRK-C

### Special options, add the appropriate letter or number

<b>input signal</b>	0-20 mA 4-20 mA 8 bit digital with hold function Profibus DP		PR...1-.... PR...2-.... PR...3-.... from G <sup>1</sup> / <sub>4</sub> on PR...8-....
<b>feedback signal</b>	0-10 V 0-20 mA 4-20 mA		PR.1.-.... PR.2.-.... PR.3.-....
<b>external feedback signal</b>	0-10 V 0-20 mA 4-20 mA		PR.4.-.... PR.5.-.... PR.6.-.... PR...-XX..
<b>deviant pressure range for vacuum</b>	indicate on order Bypass version	G <sup>1</sup> / <sub>8</sub> and G <sup>1</sup> / <sub>4</sub> G <sup>1</sup> / <sub>2</sub> G1	PR...-.V2 PR1...-.V2 PR2...-.V2 PR...-.0A PR...-.06 PR...-.SS PR...-.19 PR...-.15
<b>for absolute pressure protection class IP65</b>	special cable box, PRK-IP65		
<b>body made of stainless steel</b>	valve body and inner parts, 1.4304, EPDM seals, G <sup>1</sup> / <sub>4</sub> and G <sup>1</sup> / <sub>2</sub>		
<b>body made of aluminium for oxygen</b>	nly valve body, max. 20 bar specially cleaned, FKM elastomer	G <sup>1</sup> / <sub>4</sub> only	

### Accessories, enclosed

<b>coupling socket</b>	7-pin with 2 m cable 7-pin with 5 m cable 7-pin with 2 m cable, IP65 7-pin with 2 m cable 7-pin with 5 m cable	straight straight straight angular angular	<b>PRK-A2L</b> <b>PRK-A5L</b> <b>PRK-I2L</b> <b>PRK-C2L</b> <b>PRK-C5L</b>
<b>other cable length</b>	e.g. 10 m available		

\*1 at 6 bar supply pressure and 5 bar outlet pressure



# PR - Régulation proportionnel de pression, Airtronic, pour une multitude d'applications industrielles

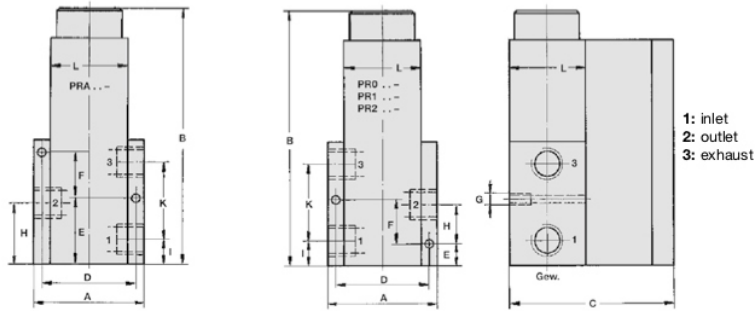

Proport. regulator	thread	A	B	C	D	E
PRA . . .	G 1/2	35	80	63	29	18
PRO . . .	G 1/4	52	105	74	43	10
PR1 . . .	G 1/2	70	150	101	57.5	12
PR2 . . .	G 1	96	190	115	79	15

Proport. regulator	F	G	H	I	K	L
PRA . . .	7	M 4	15	10	16.6	25
PRO . . .	20	M 4	16	11*	34	36
PR1 . . .	28	M 6	23	15	48.5	45
PR2 . . .	33	M 8	30	20	60	60

\* 14 mm from 30 bar pressure range on

## "AIRTRONIC"® PROPORTIONAL PRESSURE REGULATOR WITH INTEGRATED PCB

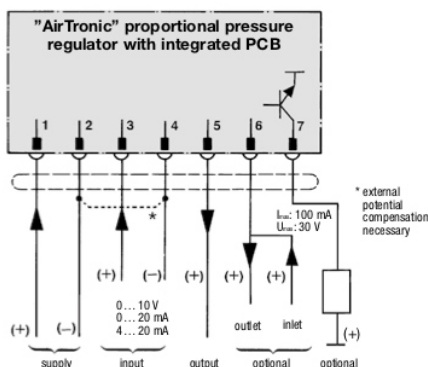

pin	4-wire	7-wire
1	white	grey
2	brown	blue
3	yellow	yellow
4	green	green
5	-	brown
6	-	white
7	-	pink

pin numbers seen from solder pin side

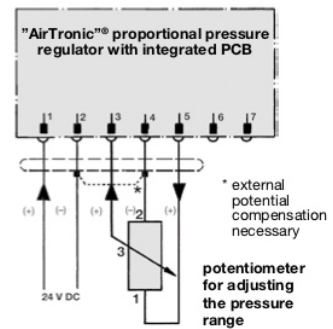

## "AIRTRONIC"® CONNECTION DIAGRAM

## CONNECTION DIAGRAM WITH POTENTIOMETER

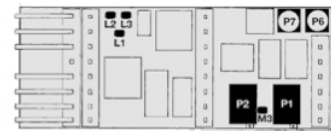
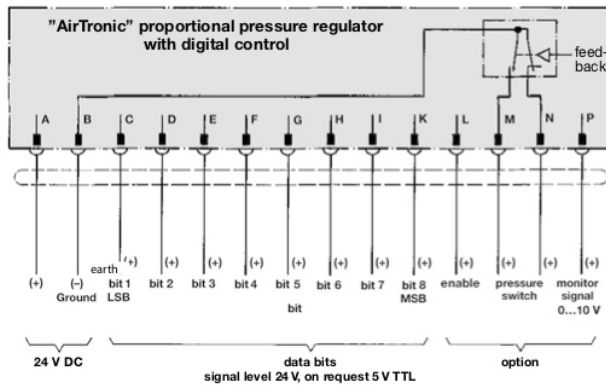

- P1 range: -10%...+5%
- P2 zero point: ± 10%
- P6 option pressure switch: 5...15%
- P7 proportional amplification: 1...11
- M3 measuring point offset zero
- L1 earth (GND)
- L2 solenoid: +24 V
- L3 solenoid (pulse width modulation): PWM

## CONNECTION DIAGRAM FOR DIGITALLY CONTROLLED PROPORTIONAL PRESSURE REGULATOR

## ADJUSTMENT OF THE PROPORTIONAL REGULATOR

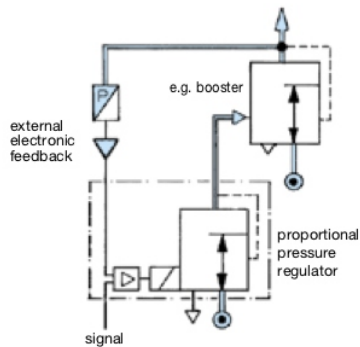

**EXTERNAL ELECTRONIC FEEDBACK**  
0 ... 10 V or 0/4 ... 20 mA

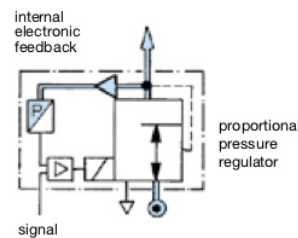

**INTERNAL ELECTRONIC FEEDBACK**  
as standard