

F4200 - Pressostat / Vacuostat Electrique

F4200 - Miniature Pressure and Vacuum Switch

Description	High-precision pressure and vacuum switch with electrical outlet signal. The microswitch satisfies UL and CSA regulations. Polysulphone of the body approved by National Sanitation Foundation. The switch also complies with FDA regulations and is suitable for water and food products.	
Media	compressed air, non-corrosive gases or liquids	
Switch contact	micro SPDT switch, covered by plastic cap	
Contact load	3 A at 230 V AC or 1.2 A at 125 V DC 10 A at 230 V AC or 0.5 A at 125 V DC	
Electrical connector	0.187" (4.75 mm) quick connector for Molex connector	
Repeatability	± 2% FS	
Certifications	CSA-certified and UL-listed	
Switching time	25 ms	
Mounting position	any	
Temperature range	4 °C to 66 °C / 40 °F to 150 °F	
Material	Body: polysulphone	Spring: stainless steel
	Diaphragm: polyurethane	Media non-contact parts: nylon, carbon fibre nylon, acetal

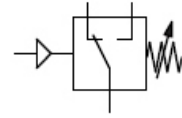

3 ... 30 mbar / 7 bar
-1 ... -10 mbar / -1 bar

Description	Contact load	Hysteresis typical	Hysteresis max.	Over-pressure max. bar	Measurement range bar	Order number
	max. A	mbar	mbar			

Pressure and vacuum switch		pressure port 1/8" NPT male, with covering cap, SPDT switch			F4200	
pressure switch	3	3	10	1	0.003 ... 0.03	F4200- 0,5PT
	10	7	20	2	0.014 ... 0.14	F4200- 2PT
	10	30	50	2	0.035 ... 0.35	F4200- 5PT
	10	70	110	3	0.035 ... 1.0	F4200- 15PT
	10	120	160	4	0.035 ... 2.1	F4200- 30PT
	10	240	350	8	0.035 ... 4.2	F4200- 60PT
	10	400	500	8	0.070 ... 7.0	F4200-100PT
vacuum switch	3	1	3	-0.3	-0.001 ... -0.01	F4200-X 4PT
	10	17	27	-1	-0.007 ... -0.17	F4200-X 5PT
	10	34	50	-1	-0.015 ... -0.34	F4200-X10PT
	10	68	100	-1	-0.050 ... -1.00	F4200-X30PT



F4200-100PT



F4200-60FM



F4200-100PM



F4200-100MM

Special options, add / change the appropriate letter or number

flush mounting	barbed fitting made of nylon, Ø 1/8", Ø 2 mm	F4200-...FMB80
panel mounting	barbed fitting made of nylon, Ø 1/8", Ø 2 mm	F4200-...PMB80
manifold mounting		F4200-...MM
barbed fittings	for FM and PM, made of nylon, Ø 1/8", Ø 2 mm	F4200-...B80
	nylon, Ø 1/8", Ø 4 mm	F4200-...B85
	polysulphone, Ø 1/8", Ø 2 mm	F4200-...P80
	polysulphone, Ø 1/8", Ø 4 mm	F4200-...P85
gold contact		F4200-...1B
factory-set switchpoint	± 5%, indicate on order	F4200-...X
free of oil and grease	specially cleaned, suitable for oxygen	F4200-...L

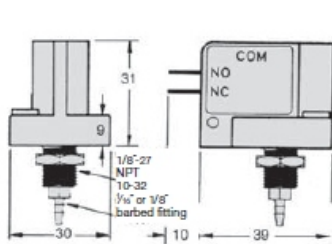

F4200-PM

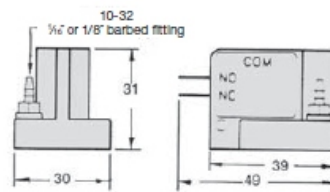

F4200-FM

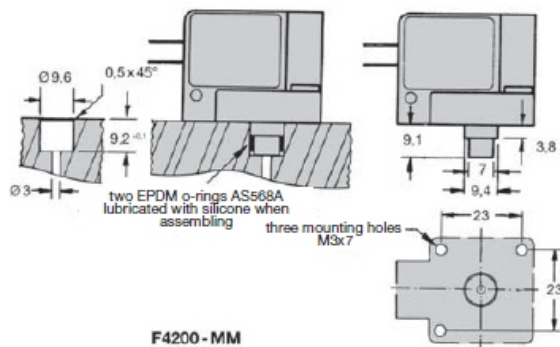

F4200-MM

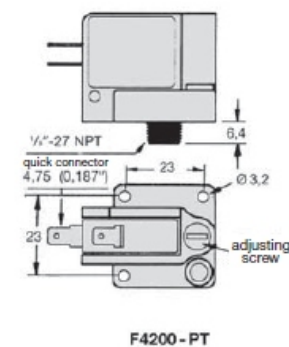

F4200-PT

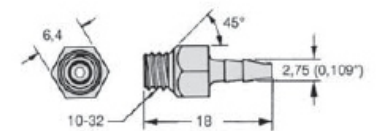

B80 / P80

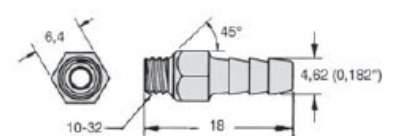

B85 / P85