

RH10 - Régulateur très haute pression, 220 bar, FKM, PTFE, compatible avec de nombreux gaz : dioxyde de carbone, argon, hélium, hydrogène, méthane, oxygène ...

Description	For outlet pressures up to 15 bar the regulator has a diaphragm, for higher outlets a piston. A sintered bronze filter at the inlet port protects against contamination.	
Media	compressed air or non-corrosive gases	
Supply pressure	max. 220 bar	
Adjustment	RH10-02: by black plastic knob	all others: by T-handle with locknut
Gauge port	All regulators are equipped with both one supply pressure gauge and one outlet pressure gauge.	
Safety relief valve	prevents from overpressure, see chart	
Compensation	All regulators are equipped with supply pressure variation compensation, so that a change in supply pressure has no effect on the outlet pressure's stability.	
Temperature range	-20 °C to 60 °C / -4 °F to 140 °F	
Material	Body: brass, nickel-plated at RH10-02 Piston: brass at RH10-02 Valve seat: nylon Diaphragm: stainless steel at RH10-02, NBR/Buna-N at all others	Mounting position any Inlet filter: sintered bronze O-rings: EPDM or FKM, dependent on media

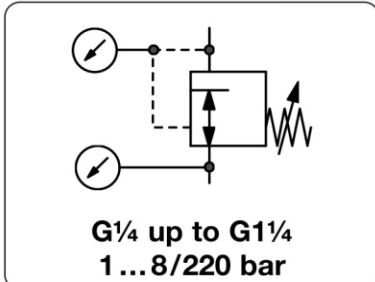

Dimensions			Safety relief valve	K _v -value	Flow rate	Connection thread	Pressure range	Order number
A	B	C						
mm	mm	mm	S: with valve	(m ³ /h)	m ³ /h*1 l/min*1	inlet / outlet	bar	

High pressure regulator 220 bar				non-relieving, for compressed air, pressure gauges supplied			RH10		
176	145	35	S	0.05	80	1300	DIN 477 / G ¹ / ₄ f	1 ... 8	RH10-02A
			S					1 ... 15	RH10-02B
176	163	35	S					3 ... 30	RH10-02C
			S					5 ... 50	RH10-02D
			S					10 ... 100	RH10-02E
			-					20 ... 200	RH10-02F
184	176	40	S	0.19	228	3800	DIN 477 / G ³ / ₈ f	0.1 ... 1.5	RH10-030
			S					1 ... 15	RH10-03B
			S					3 ... 30	RH10-03C
			S					5 ... 50	RH10-03D
184	186	40	-				RH10-04 for DIN 477 / G ¹ / ₂ f	10 ... 100	RH10-03E
			-					20 ... 200	RH10-03F
182	245	102	S	0.25	422	7000	G ³ / ₈ f / G ³ / ₈ m	0.1 ... 1.5	RH10-A30
			S					1 ... 15	RH10-A3B
182	260	102	S				RH10-A4 for G ³ / ₈ f / G ¹ / ₂ m	3 ... 30	RH10-A3C
			S					5 ... 50	RH10-A3D
182	195	35	-					10 ... 100	RH10-A3E
			-					20 ... 200	RH10-A3F
166	345	232	S	0.6	2000	33000	G ³ / ₄ a / G ³ / ₄ m	1 ... 8	RH10-06A
			S					1 ... 15	RH10-06B
166	358	245	S					3 ... 30	RH10-06C
			S					5 ... 50	RH10-06D
			-					10 ... 100	RH10-06E
253	370	242	S	1.8	3000	48000	G ¹ / ₂ m / G ¹ / ₂ m	1 ... 8	RH10-08A
			S					1 ... 15	RH10-08B
253	406	278	S					3 ... 30	RH10-08C
			S					5 ... 50	RH10-08D
253	406	278	-					20 ... 200	RH10-08F

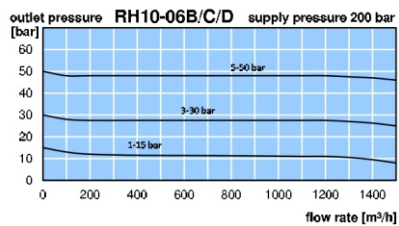
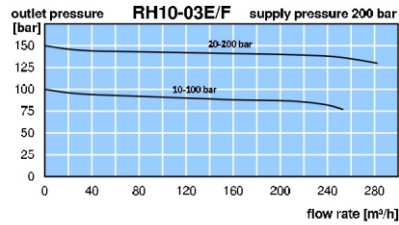
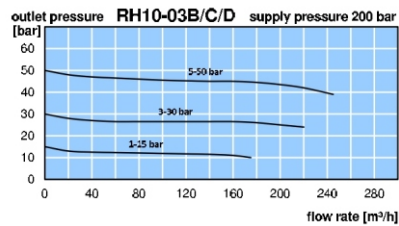
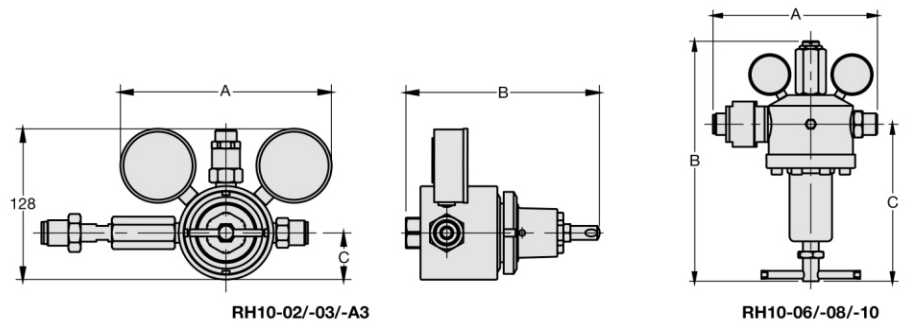

*1 at 200 bar supply pressure and 15 bar outlet pressure

*2 max. 80 bar outlet pressure



RH10 - Régulateur très haute pression, 220 bar, FKM, PTFE, compatible avec de nombreux gaz : dioxyde de carbone, argon, hélium, hydrogène, méthane, oxygène ...

Description	For outlet pressures up to 15 bar the regulator has a diaphragm, for higher outlets a piston. A sintered bronze filter at the inlet port protects against contamination.	
Media	compressed air or non-corrosive gases	
Supply pressure	max. 220 bar	
Adjustment	RH10-02: by black plastic knob	all others: by T-handle with locknut
Gauge port	All regulators are equipped with both one supply pressure gauge and one outlet pressure gauge.	
Safety relief valve	prevents from overpressure, see chart	
Compensation	All regulators are equipped with supply pressure variation compensation, so that a change in supply pressure has no effect on the outlet pressure's stability.	
Temperature range	-20 °C to 60 °C / -4 °F to 140 °F	
Material	Body: brass, nickel-plated at RH10-02 Piston: brass at RH10-02 Valve seat: nylon Diaphragm: stainless steel at RH10-02, NBR/Buna-N at all others	Mounting position any Inlet filter: sintered bronze O-rings: EPDM or FKM, dependent on media

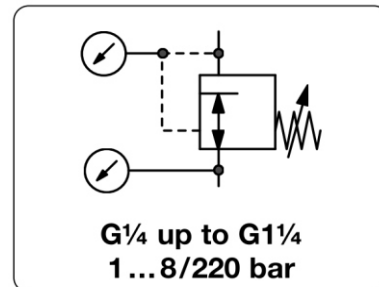

Dimensions			Safety relief valve	K _v -value	Flow rate	Connection thread	Pressure range	Order number
A	B	C						
mm	mm	mm	S: with valve	(m ³ /h)	m ³ /h*1	l/min*1	inlet / outlet	bar

High pressure regulator 220 bar				non-relieving, for compressed air, pressure gauges supplied			RH10		
248	385	270	S	3.1	5000	80000	G1m / G1¼	1... 8	RH10-10A
			S					1... 15	RH10-10B
			S					3... 30	RH10-10C
248	420	305	S					5... 50	RH10-10D



RH10-08B

Special options, add the appropriate letter

relieving	with relieving function, for compressed air	RH10-... R
FKM elastomer		RH10-... V
PTFE elastomer		RH10-... T
SST diaphragm	from RH10-03	RH10-... S
for panel mounting	for RH10-02 to -A3	RH10-... P
carbon dioxide *2	CO ₂	RH10-... 03
argon	Ar	RH10-... 05
nitrogen	N ₂	RH10-... 07
helium	He	RH10-... 09
hydrogen	H ₂	RH10-... 11
methane	CH ₄	RH10-... 13
oxygen	O ₂	RH10-... 15
propane	C ₃ H ₈	RH10-... 16
nitrous oxide	N ₂ O	RH10-... 17
without cylinder connection		RH10-... X40

Accessories, enclosed

mounting bracket	made of stainless steel	for RH10-02	BW35-01S
mounting nut		for RH10-02	M35x1,5S
mounting bracket		for RH10-03 and -A3	BW50-01S
mounting nut		for RH10-03 and -A3	M50x1,5S
mounting bracket		for RH10-06	BW00-31S
		for RH10-08	BW00-35S

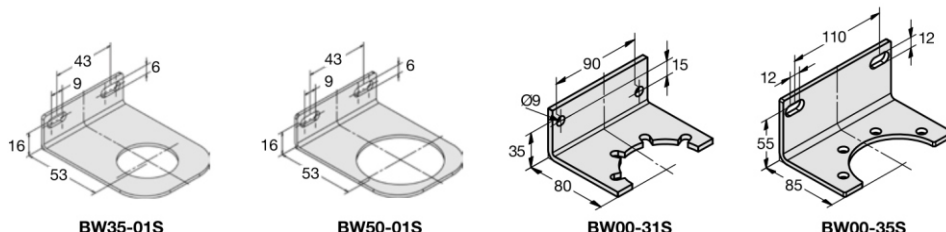
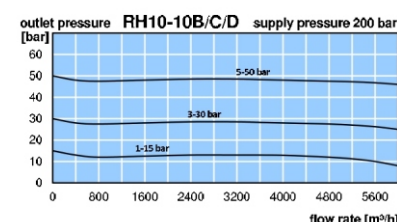
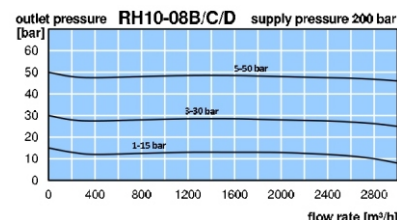

*1 at 200 bar supply pressure max. outlet pressure

*2 max. 80 bar outlet pressure

