

Description	Standard-type mist lubricator which lubricates in proportion to flow rate. Modular lubricator which can be connected to other instruments of the same series.		
Supply pressure	max. 13 bar	lubricator with semi-automatic filling device lubricator with oil level indicator	3 - 13 bar max. 7 bar
Oil refilling	With semi-automatic oil refilling, the oil is sucked by vacuum into the bowl at the push of a button without having to interrupt operation.		
Oil level indicator	If the minimum oil level is not reached, a float closes a signal contact. Contact: NO max. voltage: 115V		
Mounting	Boreholes in lubricator body for wall mounting.		
Temperatur range	0 °C to 50 °C / 32 °F to 120 °F storage temperature: -20 °C to 90 °C / -4 °F to 200 °F		
Materials	Body: POM on series 042, all others of nylon Bowl: polyamide Internal parts: brass		

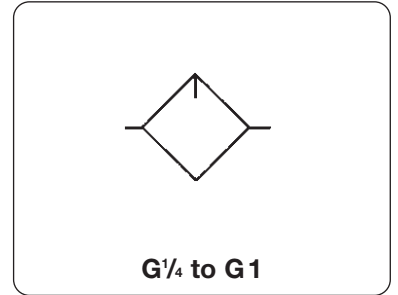

Dimensions			Bowl of / with	Bowl volume	Flow rate		Connection thread	Order number
B	H	C			cl	m ³ /h*		

Compressed air lubricator								supply pressure max. 13 bar	L0
42	157	105	plastic	42	114	1900	G ¹ / ₄		L042 - 02
63	190	132	protection cage	68	120	2000	G ³ / ₈		L050 - 03
63	190	132	protection cage	68	126	2100	G ¹ / ₂		L052 - 04
75	227	164	protection cage	140	210	3500	G ¹ / ₂		L075 - 04
137	227	164	protection cage	140	216	3600	G ³ / ₄		L080 - 06
115	305	221	protection cage	440	708	11800	G1		L095 - 08



L042-02B with protection cage **L050**



L080 **L095**

Special options add the appropriate letter

bowl with protection cage	only for L042 if required	B	L042 - 02 B
semi-automatic oil refilling	P min. 3 bar not G1	V	L0... - 0. V
oil level indicator	P max. 7 bar 115 V/NO	L	L0... - 0. L
wall mounting	C95.01.000.15/18 for G1	Y	L095 - 08 Y

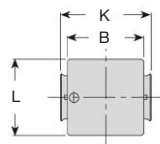
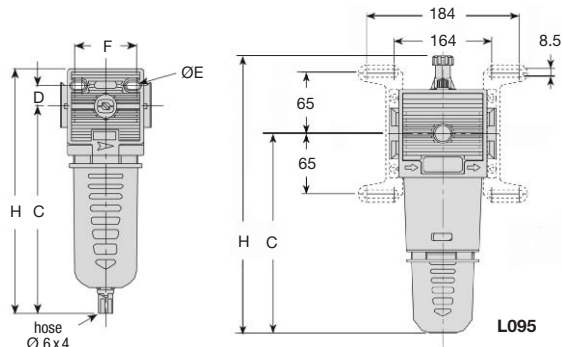

Series	D	E	F	K	L
L035	8	3.5	20	-	36
L042	10.5	4.5	31	-	42
L050/52	16	5.5	41	63	52
L075	17.5	5.5	45	75	63
L080	17.5	5.5	45	-	63
L095	65	8.5	174	115	95

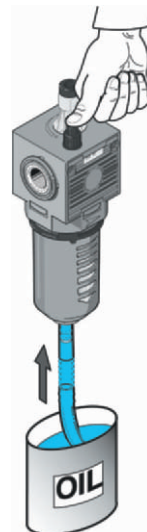

semi-automatic oil refilling

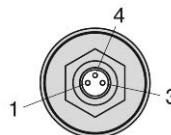

oil level indicator



oil level indicator

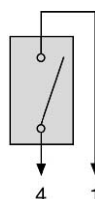

* at 10 bar supply pressure and 1 bar pressure drop

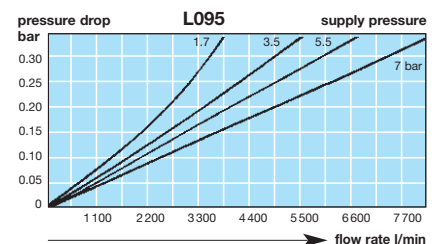
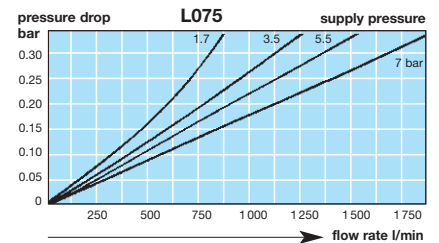
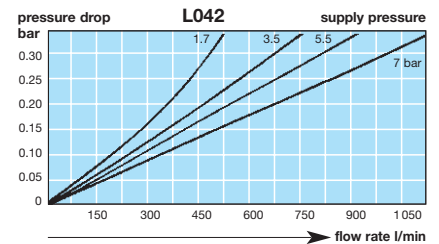

For your information:	1 bar: 14.5 psi	1 l/min: 0.035 scfm	1 mm: 0.039 inch
	1 psi: 0.069 bar	1 scfm: 28.3 l/min	1 inch: 25.4 mm



Order example:
L042 - 02